

Research Paper

# Evolution in the *Drosophila ananassae* species subgroup

Muneo Matsuda,<sup>1,\*</sup> Chen-Siang Ng,<sup>2</sup> Motomichi Doi,<sup>3,†</sup> Artyom Kopp<sup>2</sup> and Yoshiko N. Tobari<sup>4</sup>

<sup>1</sup>Kyorin University School of Medicine; Tokyo, Japan; <sup>2</sup>Department of Evolution and Ecology; University of California—Davis; Davis, CA USA; <sup>3</sup>Graduate School of Life and Environmental Science; University of Tsukuba; Tsukuba, Japan; <sup>4</sup>The Research Institute of Evolutionary Biology; Tokyo, Japan

†Present address: Advanced Industrial Science And Technology; Tsukuba, Japan

**Key words:** *D. ananassae* subgroup, molecular phylogeny, chromosomal phylogeny, reproductive isolation, speciation, *D. parapallidosa*

*Drosophila ananassae* and its relatives have many advantages as a model of genetic differentiation and speciation. In this report, we examine evolutionary relationships in the ananassae species subgroup using a multi-locus molecular data set, karyotypes, meiotic chromosome configuration, chromosomal inversions, morphological traits, and patterns of reproductive isolation. We describe several new taxa that are the closest known relatives of *D. ananassae*. Analysis of Y-chromosomal and mitochondrial haplotypes, shared chromosome arrangements, pre-mating isolation and hybrid male sterility suggests that these taxa represent a recent evolutionary radiation and may experience substantial gene flow. We discuss possible evolutionary histories of these species and give a formal description of one of them as *D. parapallidosa* Tobari sp. n. The comparative framework established by this study, combined with the recent sequencing of the *D. ananassae* genome, will facilitate future studies of reproductive isolation, phenotypic variation and genome evolution in this lineage.

*Drosophila ananassae* and its closely related species serve as a widely used model in population and evolutionary genetics. Numerous studies in *D. ananassae* have focused on genetic differentiation, natural selection, inversion polymorphism, sexual behavior and reproductive isolation.<sup>1-9</sup> The recent sequencing of the *D. ananassae* genome and the availability of whole-genome microarrays<sup>10,11</sup> will further enhance the power and utility of this model. In particular, genomic approaches may help identify the molecular-genetic and neurophysiological changes responsible for the evolution of mating behavior and sexual isolation in *D. ananassae* and its relatives.<sup>12</sup>

Comparative genetic and molecular research in *D. ananassae* and its relatives will require a phylogenetic framework. Historical information is essential for reconstructing the evolution of behavior and other phenotypic traits, understanding the demographic history

of each species, and inferring the evolutionary forces acting on molecular sequences. Evolutionary studies in *D. melanogaster* have benefited greatly from a detailed knowledge of the phylogenetic relationships, speciation patterns, and geographic and demographic history of its close relatives.<sup>13-15</sup> In this report, we seek to establish a similar comparative background for *D. ananassae*.

*D. ananassae* belongs to the ananassae subgroup of the melanogaster species group. This subgroup contains 22 described species distributed mainly throughout Southeast Asia, with some species extending into northeastern Australia, South Pacific, the Indian subcontinent and Africa.<sup>16-19</sup> Within the ananassae subgroup, three species complexes—ananassae, bipectinata and ercepeae—have been recognized based on male genital morphology.<sup>16,18,20</sup> In a recent molecular study, Da Lage et al.<sup>21</sup> used *Amyrel* gene sequences to confirm the monophyly of each species complex and resolve phylogenetic relationships within and among these complexes. In other *Drosophila* lineages, however, different loci often support different species relationships,<sup>22-24</sup> suggesting that additional sequence data may provide valuable historical information.

In this study, we examine evolutionary relationships in the ananassae subgroup using a multi-locus molecular data set, karyotypes, meiotic chromosome configuration in males, inversions, morphological traits and patterns of reproductive isolation. We have recognized several new taxa that are the closest known relatives of *D. ananassae*. Analysis of Y-chromosomal and mitochondrial haplotypes, shared chromosome arrangements, pre-mating isolation and hybrid male sterility suggests that these taxa represent a recent evolutionary radiation and may experience substantial gene flow. We discuss possible evolutionary histories of these species and give a formal description of one of them as *D. parapallidosa* Tobari sp. n.

## Results

**Evolution in the ananassae species subgroup. Species phylogeny.** Phylogenetic relationships supported by separate analyses of four nuclear loci and one mitochondrial locus are shown in Figure 1A–E. The ercepeae complex is monophyletic in all single-locus analyses, and the bipectinata complex is monophyletic in all gene trees except *Gpdbh*. *D. monieri*, *D. phaeopleura*, *D. ochrogaster* and

\*Correspondence to: Muneo Matsuda; Kyorin University School of Medicine; Mitaka, Tokyo 181-8611 Japan; Email: matsudam@ks.kyorin-u.ac.jp

Submitted: 01/14/09; Revised: 03/04/09; Accepted: 03/12/09

Previously published online as a Fly E-publication:

<http://www.landesbioscience.com/journals/fly/article/8399>

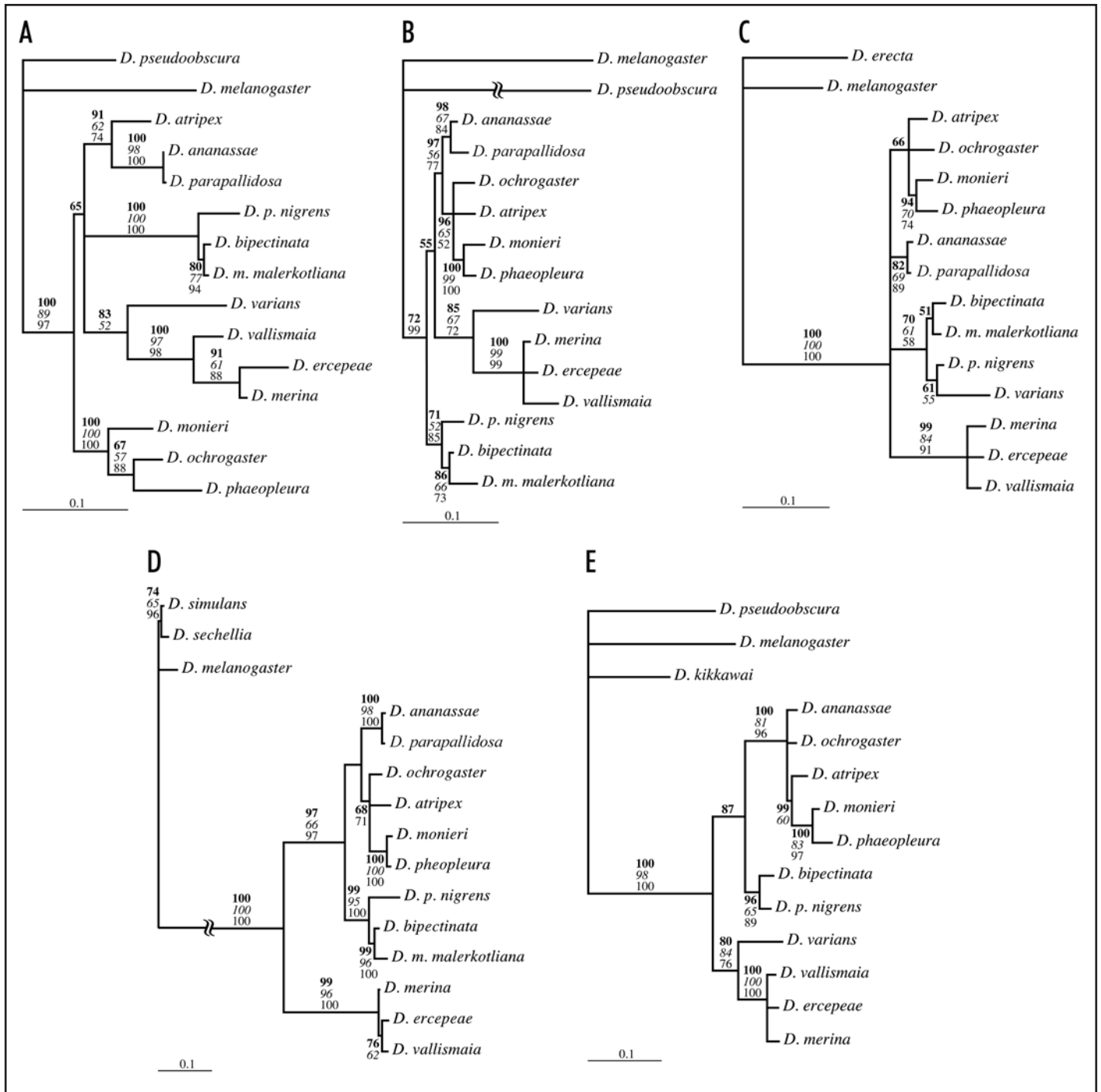

Figure 1. Phylogenetic trees reconstructed from individual loci by Bayesian analysis. The three numbers shown at each dichotomous node represent (bottom to top) maximum parsimony bootstrap value, maximum likelihood bootstrap value (*italic*), and Bayesian posterior probability of the corresponding split (**bold**). Bootstrap values below 50 are not shown. (A) *COI*; (B) *Ddc*; (C) *Gpdh*; (D) *kl2*; (E) *Pgi*.

*D. atripex* tend to be grouped with *D. ananassae* and its close relative *D. parapallidosa* in most trees. Finally, *D. varians* is usually placed close to the ercepeae complex.

In the combined analysis using concatenated sequences of all five loci, a single tree with strongly supported internal nodes was produced by maximum likelihood, parsimony and Bayesian analyses (Fig. 2). This topology is almost identical to the phylogeny

based on the *Amyrel* locus,<sup>21</sup> which was not included in our data set. The only exception is that *D. ercepeae* is most closely related to *D. merina* in our analysis, whereas in the *Amyrel* gene tree it is closer to *D. vallismaia*.

Two major clades emerge in the multi-locus phylogeny (Fig. 2). The first consists of the ercepeae species complex and *D. varians*, while the second includes the ananassae and bipectinata species

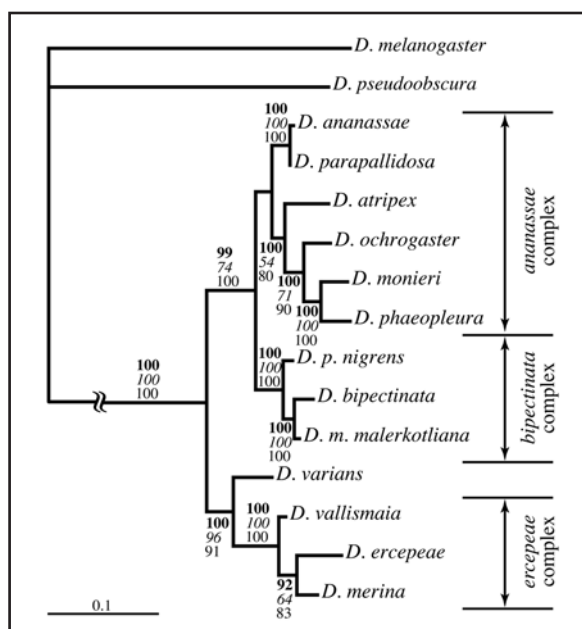

Figure 2. Maximum likelihood and Bayesian consensus tree for the combined data set. The three numbers shown at each dichotomous node represent (bottom to top) maximum parsimony bootstrap value, maximum likelihood bootstrap value (italic), and Bayesian posterior probability of the corresponding split (bold).

complexes. In the *ananassae* complex, three South Pacific species (*D. phaeopleura*, *D. monieri* and *D. ochrogaster*) cluster with the Southeast Asian *D. atripex*, with *D. ananassae* and *D. parapallidosa* forming the other monophyletic branch within this complex. Consistent with earlier reports,<sup>25</sup> *D. pseudoananassae* is the most basal species in the *bipectinata* complex.

In Bayesian analysis, posterior probabilities can be put not only on specific taxon partitions, but also on the phylogeny as a whole, by producing a sample of trees whose frequencies add up to 100%. The consensus tree topology shown in Figure 2 has an overall posterior probability of 90.4%. Leaving relationships in the *ercepeae* complex unresolved increases the tree probability to 94.4% (Fig. 3A). A consensus tree with 99.4% cumulative probability confirms the monophyletic of each major lineage in the *ananassae* subgroup, but leaves their basal relationships unclear (Fig. 3C).

We used the SH test<sup>26,27</sup> to determine the degree of congruence among individual loci. For each locus, we tested whether the optimal tree reconstructed from that locus accounted for the data significantly better than any of the alternative tree topologies. We found that all loci were compatible with the consensus multi-locus phylogeny (Table 1). The only instances of significant or marginally significant incongruence were observed between the nuclear genes and the mitochondrial *COI* locus, whereas all nuclear loci were compatible with each other.

**Morphological evolution.** Most species in the *ananassae* subgroup have “transverse” sex combs composed of several rows of thickened bristles oriented perpendicular to the proximo-distal leg axis (Fig. 4A). However, *D. bipectinata* and *D. parabipectinata* in the *bipectinata* complex have “rotated” sex combs which develop

from the same precursor bristles as the transverse sex combs of other species, but are arranged along the proximo-distal leg axis and are curved and highly melanized (Fig. 4B).<sup>25</sup> This morphology makes these two species drastically different from all other members of the *ananassae* subgroup, but is remarkably similar to the sex combs of several more distantly related *Drosophila* species.<sup>28,29</sup> Is this a result of convergent evolution, or were rotated sex combs present in the common ancestor of the *ananassae* subgroup but lost in most of its species? Bayesian reconstruction strongly favors the hypothesis that the latest common ancestor of the *bipectinata* complex had a transverse sex comb (91% probability, Bayes factor = 4.5 in favor). This conclusion is not affected by the addition of outgroup taxa outside of the *ananassae* subgroup. Thus, rotated sex combs most likely evolved independently in the *bipectinata* complex (Fig. 5).

Five out of 16 species represented in our analysis have dark male-specific pigmentation in posterior abdominal segments, while in nine species males and females are pigmented identically (Fig. 4C and D; and Fig. 5). The remaining two species—*D. malerkotliana* and *D. pseudoananassae*—are polymorphic, each having allopatric subspecies that are sexually dimorphic or monomorphic for abdominal pigmentation.<sup>20,25</sup> Both dimorphic and monomorphic taxa are found in each major lineage of the *ananassae* subgroup (Fig. 5). Bayesian reconstruction shows that the two character states have approximately equal probabilities at each of the internal nodes, with Bayes factors in support of either hypothesis not exceeding 0.2 (Fig. 5). This is not due to phylogenetic uncertainty; rather, the high frequency of transitions between sexually dimorphic and monomorphic pigmentation prevents us from reconstructing the order and direction of evolutionary changes.

**Karyotype variation.** *D. ananassae*, *D. atripex*, *D. bipectinata*, *D. vallismaia* and *D. varians*, which together represent all major lineages in the *ananassae* subgroup, have similar karyotypes consisting of medium-sized metacentric X, two large metacentric autosomes and medium or large metacentric 4<sup>th</sup> chromosomes (Fig. 6A-1-5). Males also carry a submetacentric or metacentric Y chromosome. Salivary gland nuclei show six long banded euchromatic arms, consistent with earlier reports;<sup>30-33</sup> no banding is detected on the 4<sup>th</sup> chromosome, suggesting that it is heterochromatic. In the meiotic nuclei of primary spermatocytes, a tetravalent between X, Y and 4<sup>th</sup> chromosomes is observed in all species of the *ananassae* subgroup except the three members of the *ercepeae* complex (*D. merina*, *D. vallismaia* and *D. ercepeae*) (Fig. 6B-1-5).

**Evolution in the *ananassae* species cluster.** New taxa closely related to *D. ananassae*. In the course of our work, we have identified a number of strains whose species affiliations were unclear. These strains are similar to *D. ananassae* and *D. pallidosa*, but are partially reproductively isolated from these species and have distinct chromosome arrangements. Based on phenotypic traits (Tobari YN, unpublished), chromosome variation, and reproductive isolation, we tentatively classified these strains into four taxa: *D. parapallidosa*, *D. pallidosa-like*, *D. pallidosa-like Wau* and *D. papuensis-like*. We refer to the six species including *D. ananassae*, *D. pallidosa*, and the four new taxa as the “*ananassae* species cluster”,

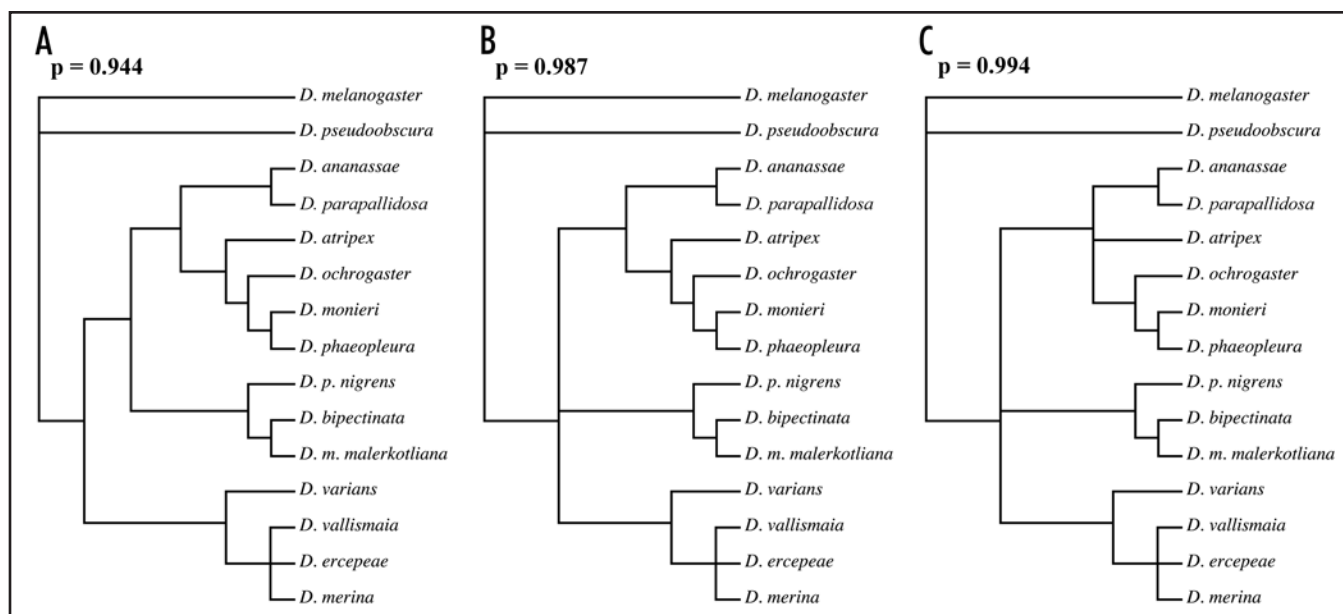

Figure 3. Credible tree sets and their cumulative posterior probabilities ( $P$ ) from combined Bayesian analysis. (A) consensus of the two most probable trees ( $p = 0.944$ ); (B) strict consensus of the three most probable trees ( $p = 0.987$ ); (C) strict consensus of the four most probable trees ( $p = 0.994$ ).

Table 1 **p values for pairwise shimodaira-hasegawa tests**

Data/Topology	<i>COI</i>	<i>Ddc</i>	<i>Gpdh</i>	<i>kl2</i>	<i>Pgi</i>	Combined
<b><i>COI</i></b>	-	0.447	0.007 <sup>a</sup>	0.075	0.008 <sup>a</sup>	0.480
<b><i>Ddc</i></b>	0.009 <sup>a</sup>	-	0.773	0.312	0.026 <sup>a</sup>	0.894
<b><i>Gpdh</i></b>	0.097	0.663	-	0.684	0.229	0.839
<b><i>kl2</i></b>	0.011	0.456	0.734	-	0.047 <sup>a</sup>	0.827
<b><i>Pgi</i></b>	0.000 <sup>b</sup>	0.265	0.388	0.292	-	0.336

<sup>a</sup>p values that are significant prior to Bonferroni correction, but not significant after the correction. <sup>b</sup>p values that are significant after Bonferroni correction.

to distinguish it from the larger “*ananassae* species complex” that also includes the more distantly related *D. atripex*, *D. monieri*, *D. ochrogaster* and *D. phaeopleura* (Fig. 1).

*D. parapallidosa* has previously been described as “Taxon K”;<sup>33,34</sup> a taxonomic description is given in Appendix A. This species is recorded from Kota Kinabalu (Borneo), Lanyu Island (Taiwan) and Okinawa (Suppl. Table 1), and appears to be most distinct from *D. ananassae* and *D. pallidosa* among the new taxa. The other three taxa are found exclusively in New Guinea (Suppl. Table 1), with the exception of a single strain of *D. papuensis-like* collected in Cairns, Australia.<sup>33</sup> The taxonomic status of *D. papuensis-like*, *D. pallidosa-like* and *D. pallidosa-like Wau* is not clear, and some of these “species” may in fact have a hybrid origin (see below).

**Molecular phylogeny of the *ananassae* species cluster.** We examined phylogenetic relationships in the *ananassae* species cluster based on the mitochondrial *COI* and the Y-chromosomal *kl2* loci. Mitochondrial and Y-chromosomal sequences do not recombine

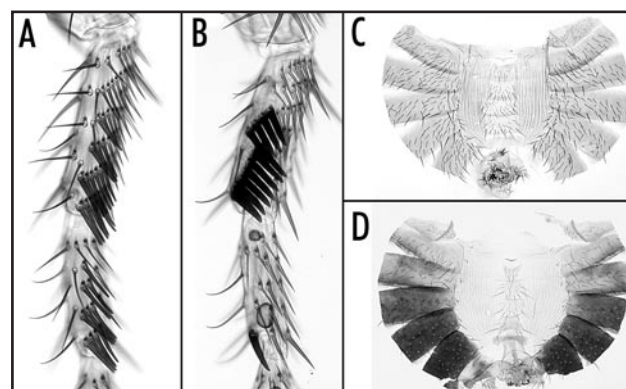

Figure 4. Sex-specific morphological traits in the *ananassae* subgroup. (A) Sex comb of *D. ananassae*; (B) sex comb of *D. parabipectinata*; (C) male abdominal pigmentation of *D. ananassae*; (D) male abdominal pigmentation of *D. parabipectinata*.

and have smaller effective populations sizes than autosomal genes, leading to more rapid coalescence and thus, potentially, to greater phylogenetic resolution among closely related taxa. Both *COI* and *kl2* haplotype networks could be rooted unambiguously using orthologous sequences from *D. atripex* and *D. monieri*, allowing us to distinguish the ancestral and derived alleles in the *ananassae* species cluster.

A total of 11 haplotypes were identified at the *COI* locus. The most common sequence is shared by five strains of *D. ananassae*, three strains of *D. parapallidosa*, three strains of *D. papuensis-like*, and one strain of *D. pallidosa* (Fig. 7A). At the same time, most species carry multiple haplotypes, which are not always directly related to each other. For example, *D. pallidosa* carries *COI* alleles separated by up to four nucleotide substitutions, while the



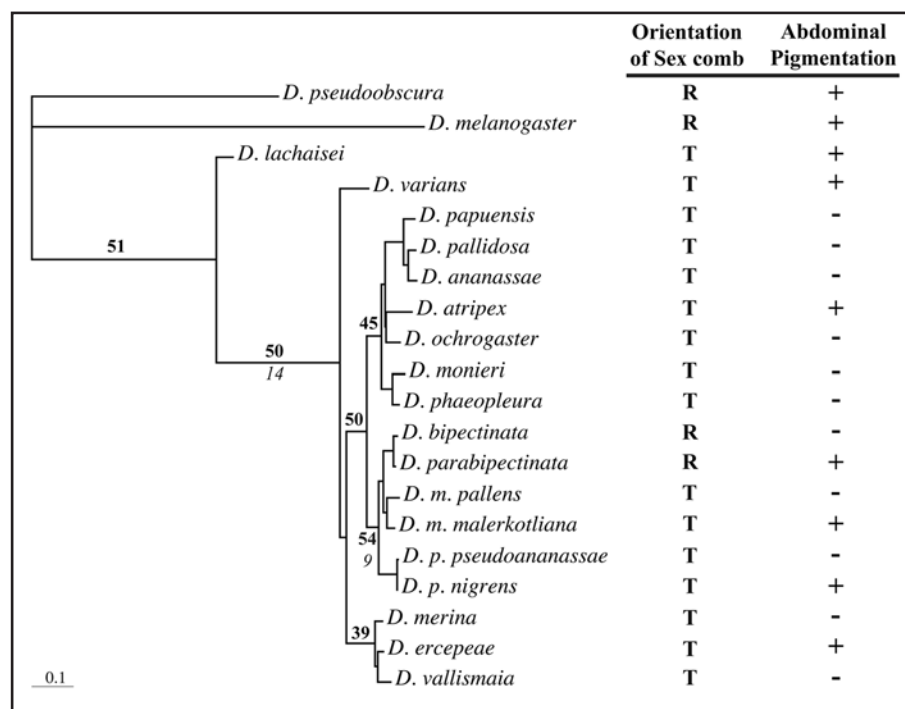

Figure 5. Phylogenetic distribution of rotated sex combs and sexually dimorphic abdominal pigmentation. The phylogeny is based on the *Amyrel* locus. "R", rotated sex comb; "T", transverse sex comb; "+", sexually dimorphic abdominal pigmentation; "-", sexually monomorphic abdominal pigmentation. Numbers at each node indicate the probabilities that the latest common ancestor of that clade had a rotated sex comb (italic) or sexually dimorphic abdominal pigmentation (bold).

intervening haplotypes are found in other species but not in *D. pallidosa*. Thus, there is little correspondence between mitochondrial haplotypes and species boundaries. Notably, three of the four most basal *COI* alleles are found in the New Guinean endemic *D. pallidosa-like* (Fig. 7A).

Four haplotypes were found at the *kl2* locus. With the exception of *D. pallidosa-like Wau*, each species carries a single allele (Fig. 7B). The most ancestral haplotype is found only in *D. pallidosa-like Wau*, and the three remaining alleles are derived independently from that haplotype. One of the derived alleles is shared by two New Guinean and two non-New Guinean taxa (*D. ananassae*, *D. pallidosa*, *D. pallidosa-like* and *D. pallidosa-like Wau*), while the other two are each restricted to a single species (*D. parapallidosa* and *D. papuensis-like*). In contrast to other nuclear loci,<sup>7,35</sup> we find no evidence of variation either within *D. ananassae* or between *D. ananassae* and *D. pallidosa* at the *kl2* locus.

**Inversion variation.** Each taxon in the *ananassae* cluster is polymorphic for a number of inversions. Collectively, these six taxa carry at least 52 paracentric inversions,<sup>34</sup> some of them unique to a single strain. Among the 32 common (non-unique) inversions, 11 are shared by Papua New Guinean and non-New Guinean taxa, 14 are restricted to a single taxon in Papua New Guinea, and seven are only present outside of Papua New Guinea (in *D. ananassae* and *D. pallidosa*) (Table 2). Thus, chromosomal diversity and the level of shared variation appear to be highest in New Guinean populations.

*D. papuensis-like* carries autosomal inversions similar to those described by David Futch from two strains collected in Papua New Guinea and informally named "*D. papuensis*".<sup>36</sup> However, these strains also carry the XLST and XRST arrangements on the X chromosome, which were not observed by Futch.<sup>36</sup> The remaining New Guinean taxa, *D. pallidosa-like* and *D. pallidosa-like Wau*, share several inversions with the South Pacific *D. pallidosa* and New Guinean populations of *D. ananassae*, although *D. pallidosa-like Wau* also carries two exclusive inversions (Table 2). The sharing of inversions among *D. ananassae*, *D. pallidosa*, and the Papua New Guinean endemics may reflect either persisting ancestral polymorphism, or gene flow between taxa. In the extreme scenario, some of the putative Papua New Guinean taxa may be the progeny of interspecific hybrids. This is especially likely for *D. pallidosa-like*, which is phenotypically variable and often intermediate between *D. ananassae* and *D. pallidosa* (Tobari YN, unpublished).

Based on the distribution of inversions, we propose a hypothesis of chromosome evolution in the *ananassae* species cluster (Fig. 8). According to this reconstruction, *D. pallidosa-like Wau* is closest to the ancestral chromosome banding patterns. This scenario is consistent with the similarity of chromosome banding patterns between this taxon and *D. monieri* (Tomimura, pers. comm.). Typical inversions of *D. parapallidosa*, *D. pallidosa* and *D. papuensis*<sup>36</sup> are derived independently from the *D. pallidosa-like Wau* arrangement through at least one, two and eight inversions, respectively. The prevailing *D. ananassae* chromosome banding patterns is derived from that of *D. parapallidosa* through five additional inversions. Finally, inversions found in *D. papuensis-like* and *D. pallidosa-like* might be explained by introgression of chromosomes from other species, especially *D. ananassae* and *D. pallidosa* (Fig. 8). Further phylogenetic and population-genetic work will be needed to test the hybridization hypothesis.

**Pre-mating reproductive isolation.** To estimate the extent of pre-mating isolation in the *ananassae* species cluster, we crossed strains representing each of the six putative taxa in all possible pairwise combinations and counted the proportion of inseminated females in each cross. This proportion varied from zero to 96%. In comparison, 83–94% of females were inseminated in intraspecific crosses (Table 3).

*D. pallidosa-like Wau* shows strong pre-mating isolation from the other five taxa (0–15% insemination), except the cross between *D. parapallidosa* females and *D. pallidosa-like Wau* males (55%, compared to 1% in the reciprocal cross). *D. papuensis-like* shows strong isolation from *D. parapallidosa*, *D. pallidosa-like* and *D. pallidosa-like Wau*, but more moderate isolation from *D. ananassae*

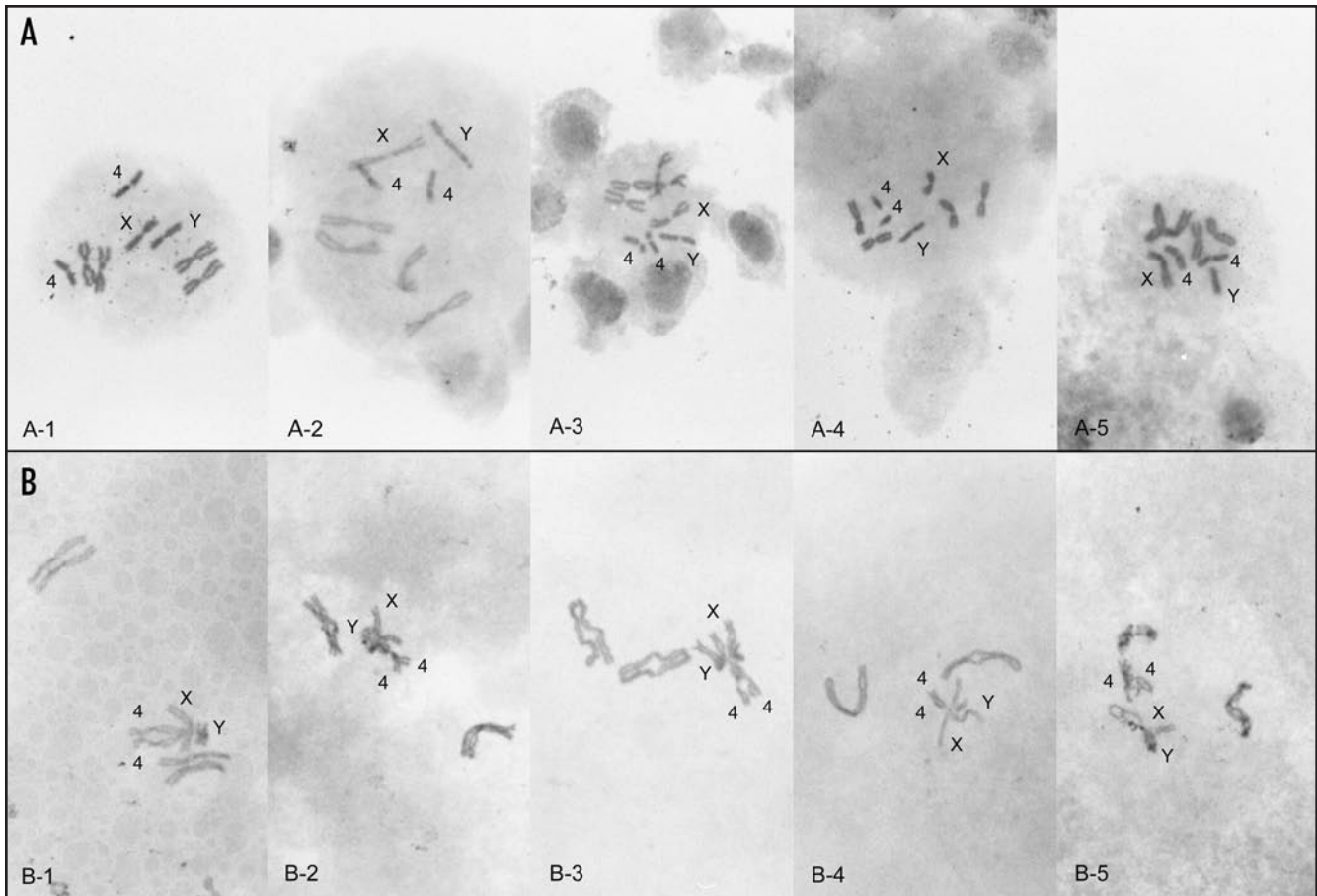

Figure 6. Karyotypes of five ananassae subgroup species. (A) Male mitotic metaphase chromosome configurations. (B) Meiotic chromosome configurations in primary spermatocytes. (1) *D. ananassae*, (2) *D. atripex*, (3) *D. bipectinata*, (4) *D. varians*, (5) *D. vallismaia*.

and *D. pallidosa*. *D. pallidosa-like* is strongly isolated from *D. pallidosa-like* Wau, *D. papuensis-like* and *D. ananassae*, but shows much weaker isolation from *D. pallidosa* and *D. parapallidosa*. Consistent with previous reports,<sup>5,36</sup> strong pre-mating isolation is observed in crosses between *D. pallidosa* males and *D. ananassae* females, but not in the reciprocal crosses. *D. ananassae* shows a similar asymmetric isolation from *D. parapallidosa*. In contrast, *D. pallidosa* shows only mild pre-mating isolation from the latter species in either direction. In general, differences in insemination success between reciprocal crosses are common in the ananassae species cluster (Table 3).

Although these observations are somewhat tentative due to the use of only one strain per taxon, they contribute to our understanding of species relationships in the ananassae cluster. In particular, pre-mating isolation among the three Papua New Guinean endemics (*D. pallidosa-like*, *D. pallidosa-like* Wau and *D. papuensis-like*) (0–15% insemination) appears to be at least as strong as between Papua New Guinean and non-New Guinean taxa (0–96%), or among different non-New Guinean taxa (0–82%) (Table 3).

**Postzygotic reproductive isolation.** F<sub>1</sub> hybrid male sterility was examined in all pairwise crosses among the six taxa of the ananassae species cluster (Table 4). No progeny were produced in

crosses between *D. papuensis-like* males and either *D. pallidosa-like* or *D. pallidosa-like* Wau females despite repeated attempts to cross different strains. This failure presumably reflects strong pre-mating isolation between these taxa (Table 3). Of the remaining 28 species pairs, fertile F<sub>1</sub> hybrid males were produced in 16 combinations, four species pairs produced only sterile males in all crosses, and the remaining eight pairs yielded either fertile or sterile F<sub>1</sub> males when different parental strains were used (Table 4).

Ten of the 16 species pairs that produced fertile male hybrids involved either *D. ananassae* or *D. pallidosa* as the male parent. In contrast, sterile hybrid males were found almost exclusively in crosses involving *D. parapallidosa*, *D. pallidosa-like* Wau or *D. pallidosa-like* as the male parent (Table 4). *D. parapallidosa* shows particularly strong isolation from the other species. Seven out of eight species pairs that show variable sterility involve at least one Papua New Guinean endemic taxon. In combination with pre-mating isolation and shared chromosome arrangements, these observations suggest that the Papua New Guinean taxa are somewhat distinct from each other and from the non-New Guinean species, but may be experiencing substantial gene flow. Their taxonomic status is uncertain, and they may represent either incipient species in early stages of divergence or hybrid “taxa” produced by secondary admixture.

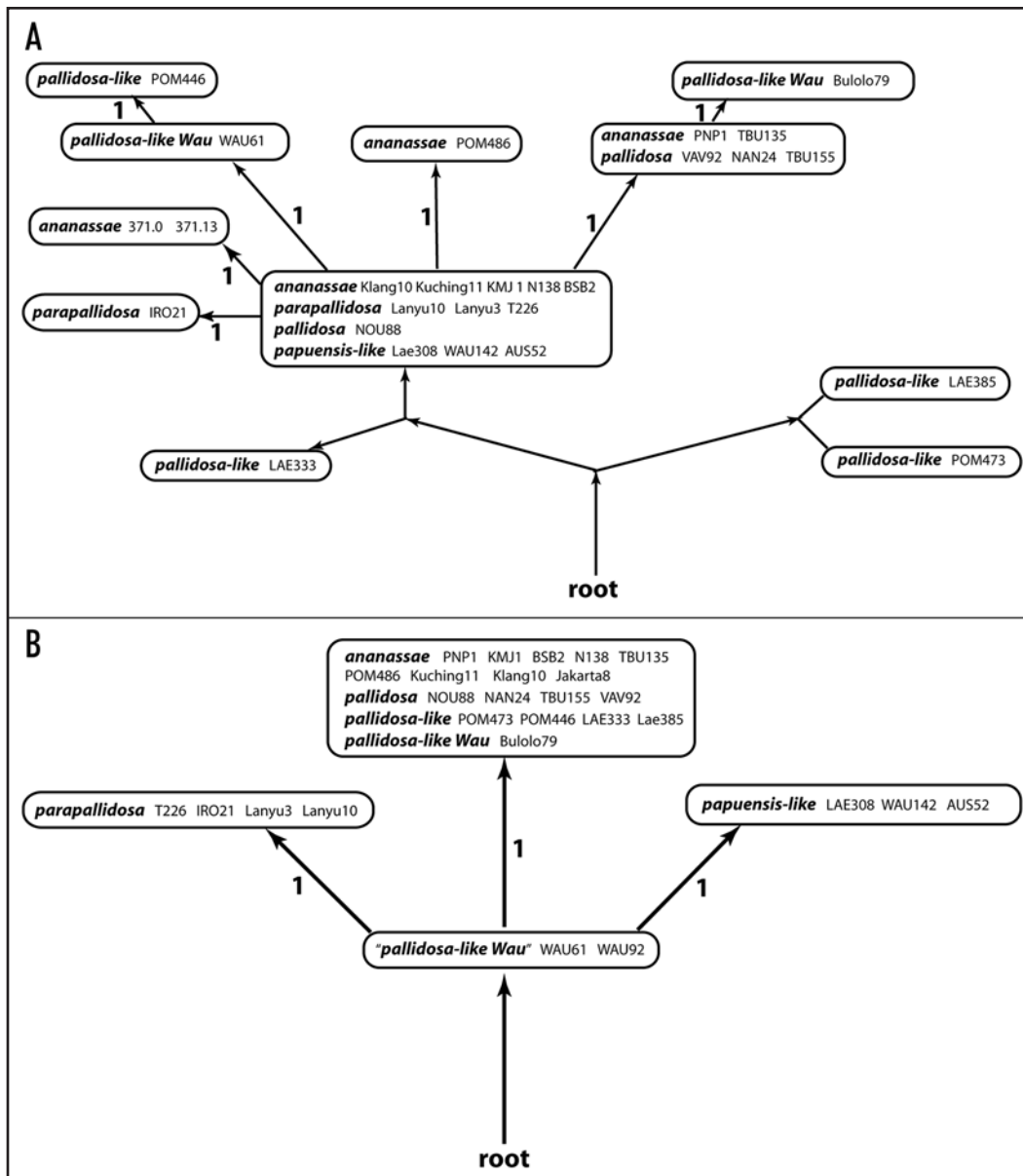

Figure 7. Phylogenetic relationships among mitochondrial and Y-chromosomal alleles in *D. ananassae* and its close relatives. (A) Mitochondrial *COI* locus. (B) Y-chromosomal *kI2* locus. Both haplotype networks are rooted using sequences from *D. atripex* and *D. monieri*. Numbers reflect nucleotide substitutions separating neighboring haplotypes.

## Discussion

**Basal relationships in the *ananassae* species subgroup.** Phylogenetic analysis reveals two major lineages within the *ananassae* subgroup. The first lineage is composed of the *ananassae* and *bipectinata* species complexes, and the other of the *erceptae* complex and *D. varians*. Our analysis confirms the earlier results of Da Lage et al.<sup>21</sup> which were based on entirely different data. The agreement between two independent reconstructions and the strong support for the consensus phylogeny provide a robust historical framework for the studies of phenotypic evolution and speciation. Although *D. varians* has sometimes been grouped with the *ananassae* complex based

on the morphology of male genitalia,<sup>19</sup> the new molecular phylogenies suggest that morphological similarities may reflect convergent evolution.

The center of distribution of the *ananassae* subgroup is clearly in Southeast Asia. Both major lineages are represented in this region, with some species of the *ananassae* and *bipectinata* species complexes extending into northeastern Australia and the South Pacific. The main exception is the *erceptae* complex, which is composed of insular endemics in the Indian Ocean where *D. erceptae* occurs in La Reunion, *D. vallismaia* in the Seychelles, and *D. merina* in Madagascar.<sup>16</sup> The only species native to Africa, *D. lachaisei*, was not included in our analysis but was placed as the most basal lineage in the *ananassae* subgroup in the *Amyrel* gene

Table 2 Chromosome arrangements in the ananassae species cluster

Arrangement <sup>a</sup>	Gene order	Species <sup>b,c</sup>
<b>X chrom.</b>		
XLST	1A-13D	ana, pal-l, pal-l-W, pap-l
XLA	1A-4A/10D-4A/10D-13D	pal, pal-l, pal-l-W
XL(A + B)	1A-4A/10D-4A/10D-11B/13C-11B/13C-13D	pap-l
XRST	14A-20D	ana, pal, pal-l, pal-l-W, pap-l, ppl
XRA	14A-16C/19D-16C/19D-20D	pap-l
<b>2<sup>nd</sup> chrom.</b>		
2LST	21A-44D	ana
2LA*	21A-22C/37C-22C/37C-44D	ana
2LJ	21A/26B-21A/26B-44D	ana
2L(C + B)	21A-22A/28A-22A/28A-37D/41B-37D/41B-44D	pal-l, pal-l-W, ppl
2L(CD + B)	21A-22A/28A-26C/30D-28A/22A-26C/30D-37D/41B-37D/41B-44D	pal, pal-l, pal-l-W
2L(CD + BI)	21A-22A/28A-26C/30D-28A/22A-26C/30D-32A/40C-41B/37D-32A/40C-37D/41B-44D	pal-l-W
2L(C + BE)	21A-22A/28A-22/28A-29A/39C-41B/37D-29A/39C-37D/41B-44D	pap-l
2L(CG + BEF)	21A-21D/25B-28B/22A-21D/25B-22A/28A-29A/39C-41B/37D-30C/41C-41B/37D-39C/29A-30C/41C-44D	pap-l
2RST	45A-63D	ana, pal
2RA	45A-55B/62C-55B/62C-63D	pal, pal-l, pal-l-W, ppl
2RAB	45A-50B/58D-62C/55B-50B/58D-55B/62C-63D	pal, pal-l, ppl
2R(D + A)	45A-48C/53B-48C/53B-55B/62C-55B/62C-63D	pap-l
2R(D + AC)	45A-48C/53B-48C/53B-55B/62C-58D/63D-62C/55B-58D/63D	pap-l
2RK	45A-53B/48C-50C/55C-62C/55B-53B/48C-50C/55C-55B/62C-63D	pap-l
2RL	45A-53B/48C-51D/57C-55C/50C-51D/57C-62C/55B-53D/48C-50C/55C-55B/62C-63D	pap-l
<b>3<sup>rd</sup> chrom.</b>		
3LST	64A-81D	ana, pal, pal-l, pal-l-W, ppl
3LA*	64A/75B-64A/75B-81D	ana
3LC	64A-65B/73D-65A/73D-81D	pap-l
3LE	64A-65B/78A-65B/78A-81D	pal-l, pal-l-W, ppl
3RST	82A-99D	ana, pal-l, pal-l-W, pap-l, ppl
3RA*	82A-83C/87B-83C/87B-99D	ana
3RJ	82A-94A/97C-94A/97C-99D	ana
3RB	82A-87A/98D-87A/98D-99D	pal, pal-l, pal-l-W, ppl
3RBC	82A-87A/98D-96B/99C-98D/87A-96B/99C-99D	pap-l
3RI	82A-84C/99A-84C/99A-99D	pap-l
3RIK	82A-86C/94C-90B/93A-90B/93A-84C/99A-99D	pap-l
3RBG	82A-86B/94C-98D/87A-86B/94C-87A/98D-99D	pal-l-W

<sup>a</sup>Unique arrangements found in only one strain are excluded. <sup>b</sup>Species abbreviations: ana: *D. ananassae*, pal: *D. pallidosa*, pal-l: *D. pallidosa-like*, pal-l-W: *D. pallidosa-like Wau*, pap-l: *D. papuensis-like*, ppl, *D. parapallidosa*. <sup>c</sup>Complete list of examined strains is given in Supplement Table 1. \*Cosmopolitan inversions found in *D. ananassae*.

tree.<sup>21</sup> If we assume that the ananassae subgroup, like the melanogaster species group as a whole, originated in Southeast Asia,<sup>18,19,37</sup> this distribution can be explained by two independent colonization events: one by *D. lachaisei*, and one by the common ancestor of the ercepeae complex.

The karyotypes of all members of the melanogaster species group except the ananassae subgroup are characterized by an

acrocentric X chromosome, a submetacentric Y, and a small dot 4<sup>th</sup> chromosome. In polytene nuclei, the 4<sup>th</sup> chromosome can be seen to have a small banded euchromatic region. In contrast, mitotic nuclei of ananassae subgroup species have a metacentric X and a large or medium meta- or submetacentric 4<sup>th</sup> chromosome. The X chromosomes of *D. melanogaster* and *D. ananassae* carry orthologous genes (Drosophila 12 Genomes Consortium 2007),



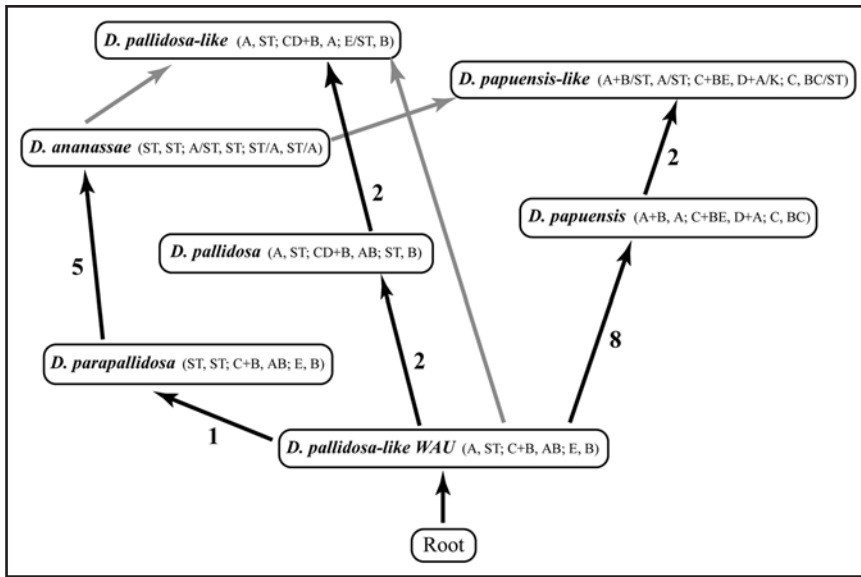

Figure 8. Phylogenetic relationships in the ananassae species cluster based on chromosome arrangements.

indicating that the metacentric X of *D. ananassae* was derived from an ancestral acrocentric X through a pericentric inversion at the base of the ananassae species subgroup. Elongation of the 4<sup>th</sup> chromosome from a dot to a large metacentric in the ananassae subgroup was caused by an accumulation of repetitive sequences.<sup>38</sup> Though orthologous genes are present on the 4<sup>th</sup> chromosome in *D. melanogaster* and *D. ananassae* (Drosophila 12 Genomes Consortium 2007), this chromosome is not polytenized in any species of the ananassae subgroup. Processes that led to the expansion of 4<sup>th</sup>-chromosome heterochromatin in this lineage remain to be elucidated.

There is an intriguing disagreement between molecular phylogeny and chromosome structure. A tetravalent involving the X, Y and 4<sup>th</sup> chromosomes is observed during male meiosis in *D. ananassae*<sup>33,39</sup> and all other species of the ananassae subgroup except the ercepeae complex. The formation of this tetravalent suggests a translocation between the X and 4<sup>th</sup> chromosomes, or a transposition of pairing sites from both sex chromosomes to the 4<sup>th</sup>. This meiotic configuration is not found in other lineages of the melanogaster species group, in the obscura species group, or in subgenus *Drosophila* (Matsuda M, unpublished), indicating that it is a derived character state in the ananassae subgroup. In addition, Roy et al.<sup>40</sup> found that an NOR is present on the 4<sup>th</sup> chromosome of *D. varians* and the ananassae and bipectinata complexes, but not on the 4<sup>th</sup> chromosome of the ercepeae complex. There are two possible explanations for the fact that the X/Y/4<sup>th</sup> tetravalent is present in the ananassae and bipectinata complexes and in *D. varians*, but not in the ercepeae complex. First, the molecular phylogeny (Fig. 2 and Da Lage et al. 2007) may be wrong, and the ercepeae complex is actually the most basal lineage in the ananassae subgroup while *D. varians* is closer to the ananassae and bipectinata complexes than to the ercepeae complex. Conversely, the tetravalent may have evolved at the base of the ananassae

subgroup but was subsequently lost in the ercepeae complex.

**Evolution of male sexual characters in the ananassae subgroup.** Male sexual characters tend to evolve rapidly due to sexual selection. In many groups of organisms, gains and losses of such traits appear to be equally common.<sup>41,42</sup> This is precisely the pattern we observe for male-specific abdominal pigmentation in the ananassae subgroup. Gains and losses of sexually dimorphic pigmentation have been equally likely in the history of this lineage, and so frequent that ancestral character states cannot be reconstructed. Given the similarity of color patterns among sexually dimorphic species, it is possible that the common ancestor of the ananassae subgroup was polymorphic for male abdominal pigmentation, and that the distribution of this trait among extant species is due to ancient lineage sorting rather than to convergent evolution. Identification of genes responsible for the development of color patterns<sup>43</sup> may help clarify this issue.

Sex combs, on the other hand, offer a strongly supported example of convergent evolution. Phylogenetic analysis shows that the common ancestor of *D. bipectinata* and *D. parabiptinata* independently evolved rotated sex combs that are similar to sex comb structures seen in more distant relatives of the ananassae subgroup.<sup>29</sup> *D. bipectinata* and *D. parabiptinata* are closely related to *D. malerkotliana*, which has transverse sex combs typical of the ananassae subgroup, and the three species appear to have diverged only 283,000 to 385,000 years ago.<sup>25</sup> Thus, the origin of rotated sex combs in the bipectinata complex is a recent evolutionary event.

**The ananassae species cluster.** Several population-genetic studies have focused on elucidating the demographic history of *D. ananassae*. Baines et al.<sup>6</sup> and Das et al.<sup>7</sup> showed that the highest levels of genetic diversity are found in regions that were part of the Sundaland during the last major glacial maximum, and suggested that *D. ananassae* originated in that area and spread to the Indian subcontinent, Australia and South Pacific islands. A recent analysis of microsatellite variation supports several separate migrations from Southeast Asia into the South Pacific region.<sup>1</sup> Substantial pre-mating isolation among several South Pacific populations of *D. ananassae* suggests that these populations may be undergoing initial stages of speciation.<sup>44</sup>

Building on previous reports,<sup>45</sup> we show that several undescribed taxa closely related to *D. ananassae* and *D. pallidosa* are found in New Guinea and Southeast Asia. These taxa show incomplete reproductive isolation from each other and from *D. ananassae* and *D. pallidosa*, leaving their taxonomic status uncertain. We used Y-chromosomal and mitochondrial haplotypes to elucidate evolutionary relationships in the ananassae species cluster. Mitochondrial DNA is widely employed in phylogenetic studies of closely related species due to its rapid coalescence and lack of recombination. However, an increasing amount

**Table 3 Insemination success in interspecific and intraspecific crosses in the ananassae species cluster**

	Male	<i>pallidosa</i> -like Wau	<i>papuensis</i> - like	<i>parapallidosa</i>	<i>pallidosa</i>	<i>ananassae</i>	<i>ananassae</i>	<i>pallidosa</i> - like
Female		(WAU61)*	(WAU142)	(T184)	(NAN4)	(HW)	(Tonga)	(POM73)
<i>D. pallidosa</i> -like Wau		83 (80) **	0 (81)	1 (92)	1 (90)	0 (75)	0 (79)	0 (89)
<i>D. papuensis</i> -like		15 (91)	94 (82)	7 (70)	24 (82)	44 (80)	4 (82)	14 (102)
<i>D. parapallidosa</i>		55 (91)	0 (71)	93 (90)	68 (81)	44 (66)	49 (87)	96 (92)
<i>D. pallidosa</i>		1 (85)	72 (67)	82 (85)	86 (56)	67 (78)	24 (78)	89 (94)
<i>D. ananassae</i> (HW)		15 (91)	15 (72)	8 (90)	2 (90)	91 (78)	79 (81)	17 (91)
<i>D. ananassae</i> (Tonga)		3 (69)	3 (70)	0 (72)	1 (78)	83 (69)	86 (72)	16 (80)
<i>D. pallidosa</i> -like		6 (95)	0 (67)	46 (91)	20 (90)	1 (70)	0 (72)	88 (88)

\*See Supplement Table 1 for strain information. \*\*The first number in each cell is the percentage of inseminated females, and the number in parentheses is the total number of dissected females.

of evidence suggests widespread introgression of mtDNA across species boundaries, questioning the value of mitochondrial gene trees for inferring species relationships.<sup>46,47</sup> Y-chromosomal loci also experience rapid coalescence, but, in contrast to mtDNA, interspecific introgression of the Y-chromosome is unlikely in male-heterogametic animals due to hybrid male sterility. Y-chromosomal sequences were found to be useful for reconstructing population history in humans,<sup>48-50</sup> other mammals<sup>51-53</sup> and *Drosophila*<sup>46,54</sup>

Despite major topological differences, both Y-chromosomal and mtDNA phylogenies show that the most basal alleles are found in Papua New Guinea (Fig. 7). Basal position of New Guinean taxa is further supported by chromosomal rearrangements (Fig. 8). It is possible, therefore, that *D. ananassae* originated as part of a New Guinean radiation before spreading to Southeast Asia, while its sibling taxa remained in New Guinea or, in the case of *D. pallidosa*, migrated eastward to colonize South Pacific islands. The lack of interspecific and geographic differentiation at the *kl2* locus suggests that these events took place recently, and that much of the genetic variation found in *D. ananassae* may pre-date its divergence from *D. pallidosa*, *D. parapallidosa*, and other relatives. The subsequent range expansion of *D. ananassae* as a human commensal may have brought it into secondary contact with the other species after partial reproductive isolation has evolved. Consistent with this scenario, shared chromosome rearrangements and mitochondrial alleles offer tentative evidence of gene flow among *D. ananassae*, *D. pallidosa*, and the New Guinean taxa. We suggest that future population-genetic studies in *D. ananassae* should include New Guinean populations of this species, as well as the other New Guinean taxa and *D. pallidosa*.

**Materials and Methods**

**Species and strains.** A total of 17 species from the ananassae subgroup were represented in this study. Strains used for molecular phylogenetic reconstruction, chromosome analyses and tests of reproductive isolation are listed in Supplement Table 1. Sequences

**Table 4 Hybrid male sterility in the ananassae species cluster**

	Male	1	2	3	4	5	6
1. <i>D. ananassae</i>		-	11/11 (14)	19/19 (48)	18/18 (42)	0/6 (27)	0/2 (9)
2. <i>D. pallidosa</i>		4/4 (4)	-	36/36 (79)	11/11 (29)	0/10 (10)	1/2 (14)
3. <i>D. pallidosa</i> -like		17/17 (41)	27/28 (86)	-	NP (4)	1/2 (2)	2/2 (6)
4. <i>D. papuensis</i> -like		17/17 (56)	27/28 (31)	1/2 (3)	-	1/3 (9)	1/1 (15)
5. <i>D. parapallidosa</i>		17/18 (18)	22/22 (27)	4/6 (6)	1/1 (9)	-	1/5 (5)
6. <i>D. pallidosa</i> -like Wau		1/1 (4)	1/1 (3)	2/4 (9)	NP (17)	0/2 (2)	-
Total number of strains examined		8	13	37	28	4	2

F<sub>1</sub> hybrid males: (white)—fertile; (grey)—partially sterile; (black)—sterile; NP—no F<sub>1</sub> progeny obtained. In each cell, top line: number of crosses that produced fertile F<sub>1</sub> males/number of crosses that produced any F<sub>1</sub> progeny. bottom line: number of crosses attempted between different pairs of strains.

from *D. melanogaster*, *D. erecta*, *D. kikkawai* and *D. pseudoobscura* were used as outgroups to root phylogenetic trees.

**Chromosome preparation.** Mitotic metaphase chromosomes were prepared from the ganglia and brains of third instar larvae of *D. ananassae*, *D. atripex*, *D. bipectinata*, *D. vallismaia* and *D. varians*, using one strain per species (Suppl. Table 1). Male meiotic chromosomes were prepared from the testes of newly emerged adults of the same strains. Tissues were dissected in hypotonic solution (1% sodium citrate) containing 5 ug colchicine/100 ml DW. Chromosomes were fixed in ethanol-acetic acid solution and the slide was air-dried. Finally, chromosomes were stained with 4% Giemsa.<sup>39</sup>

For polytene chromosome preparations, well-fed third instar larvae were dissected in a few drops of saturated carmin solution in 45% acetic acid. Salivary glands were immediately transferred to 2% orcein solution in equal parts of glacial acetic acid and lactic acid, and squashed one-two hours later.<sup>32</sup>

**Interspecific hybridization.** For pre-mating isolation tests, ten two-day old virgin females and ten two-day old males were placed

together in a vial and kept at 25°C under a 12L/12D light cycle. After two days, females were dissected and checked for the presence of sperm in the spermathecae and ventral receptacle. Ten replicate crosses were carried out, and about 100 females were examined, for each species pair. Intraspecific crosses were performed as controls. One isofemale line per species was used in these experiments (Suppl. Table 1).

95 isofemale lines (Suppl. Table 1) were used to test hybrid fertility. The number of different crosses per species pair ranged from two to 86, depending on the availability of parental lines. We used all available strains of *D. pallidosa-like*, *D. pallidosa-like Wau*, *D. papuensis-like* and *D. parapallidosa*, and a subset of strains of *D. ananassae* and *D. pallidosa*. In preliminary tests, we confirmed that all crosses between isofemale lines belonging to the same taxon recognized on the basis of morphology and chromosomal inversions produced fertile F<sub>1</sub> males and females. To test the fertility of hybrid males, ten virgin females and ten males from different taxa were placed in each vial to obtain F<sub>1</sub> progeny. F<sub>1</sub> flies from each cross were kept in new vials for one week. Adults were then discarded, and F<sub>2</sub> flies that emerged were counted. Emergence of F<sub>2</sub> progeny showed that at least some of the F<sub>1</sub> males were fertile. F<sub>1</sub> females from all crosses were fertile, as were F<sub>1</sub> males from intraspecific crosses.

**Molecular sequences.** Our sequence sample included partial genomic sequences of three 3<sup>rd</sup> chromosome loci (*Ddc*, *Gpdh* and *Pgz*), a Y-chromosomal locus (*kl2*), and the mitochondrial *COI* locus. DNA was extracted from a single male of each species using live strains maintained in our laboratories. Gene fragments were amplified by PCR and sequenced directly using the forward and reverse amplification primers. ABI chromatograms were examined by eye and corrected, if needed, using FinchTV 1.4 (Geospiza, Seattle, WA). Heterozygous nucleotide positions, if present, were represented by IUPAC ambiguity codes. Genebank accession numbers for newly generated sequences are listed in Supplement Table 1, and the primers used to amplify each locus are shown in Supplement Table 2.

Sequences were aligned using ClustalW.<sup>55</sup> Alignments were imported into MacClade 4.03,<sup>56</sup> and edited manually as needed. To ensure correct alignment, all coding sequences were translated into proteins and the protein alignments were used to confirm and correct the nucleotide sequence alignments. The *Gpdh* gene fragment contained a short intron that could not be aligned reliably and was excluded. The sequences of all five loci were concatenated for combined analysis.

**Phylogeny reconstruction.** Each locus was first analyzed separately by maximum parsimony and maximum likelihood in PAUP\* 4.0b4a.<sup>57</sup> Prior to maximum likelihood analysis, substitution model parameters for each gene and for the combined data set were estimated using likelihood ratio tests implemented in Modeltest 3.7,<sup>58</sup> and PAUP\* (Suppl. Table 3). Maximum parsimony and maximum likelihood trees were reconstructed by heuristic searches with random order of sequence addition and branch swapping by tree bisection-reconnection. Node stability was evaluated by 1,000 replicates of nonparametric bootstrapping for maximum parsimony and 100 replicates for maximum likeli-

hood. Nodes with bootstrap values below 50% were treated as unresolved polytomies.

Compatibility among phylogenetic trees based on the sequences of different genes was tested using the Shimodaira-Hasegawa (SH) test<sup>26,27</sup> in PAUP\*. To assess compatibility between two loci (A and B), the optimal tree reconstructed from locus A was compared to the optimal tree reconstructed from locus B under the maximum likelihood model estimated for locus A. Statistical significance of test values was assessed using the Bonferroni-corrected p value of 0.002, which corresponds to the experiment-wise p = 0.05 divided by the number of comparisons.

Bayesian analysis of the combined data set was performed using MrBayes v3.0.<sup>59</sup> One cold and three heated chains with default heating ratios were employed. Each analysis was run for 2,300,000 generations, with the first 300,000 generations discarded, and the trees were sampled every 1,000 generations for a total of 2,000 trees which were then summarized using majority-rule consensus trees. Substitution model parameters were estimated as part of the analysis, starting from default priors. All loci were constrained to the same tree topology, but each was allowed to have a different substitution model and a different set of branch lengths. Analysis was repeated nine times starting with random trees. Each time the analysis produced an identical tree topology and similar partition probabilities.

**Estimation of ancestral morphological character states.** Ancestral states of morphological characters were estimated using *BayesMultiState* ([www.evolution.rdg.ac.uk/BayesTraits.html](http://www.evolution.rdg.ac.uk/BayesTraits.html)), which fits continuous-time Markov models of evolution for discrete characters. To reconstruct the rates of gain and loss of characters and their likely ancestral states, estimates of their values are sampled from a probability distribution of phylogenetic trees and trait evolution scenarios.<sup>60</sup> Input trees were generated by *MrBayes* from *Amyrel* gene sequences.<sup>21</sup> We used *Amyrel* gene trees rather than trees based on the combined data set because the two phylogenies were essentially similar and the *Amyrel* data set included a larger number of taxa. Trees sampled from *MrBayes* analysis were thinned to minimize autocorrelation of estimated parameters, leaving a set of 230 trees in which the neighboring trees were separated by 11,000 generations. *BayesMultiState* analysis was performed using reversible-jump Markov chain Monte Carlo (MCMC) with prior parameters drawn from a gamma hyperprior distribution.<sup>61</sup> The proposal parameter (*ratedev*) and parameters of the hyperprior distribution were chosen so that acceptance rates of the MCMC chain varied from 20 to 40%. Analysis was run for 10,000,000 generations after discarding 200,000 generations as burn-in. Trait evolution parameters and ancestral character states were sampled every 10,000 generations.

Sex comb rotation and the presence of sexually dimorphic abdominal pigmentation were coded as binary traits (present/absent). For each internal node, we estimated the probabilities that the corresponding common ancestors had a rotated sex comb or sexually dimorphic pigmentation. We then tested whether the probability of the more likely ancestral state at each internal node was significantly greater than the probability of the alternative character state. The fit of the two alternative hypotheses was



compared using Bayes factors, which were estimated as twice the difference of the harmonic log-likelihood means of the better- and worse-fitting models. One ancestral character state was considered more likely than the alternative state if the Bayes factor at that node exceeded 2.<sup>60</sup>

### Acknowledgements

We are grateful to Marie-Louise Cariou, Françoise Lemeunier, and the Tucson species stock center for providing *Drosophila* strains, and to Hui-Jie Lee and Chun-Chuan Chang for collecting sequence data. We thank Drs. B. Barker-Hudson and P. Barker-Hudson for collecting flies in Papua New Guinea. Muneo Matsuda thanks National BioResource Project from the Ministry of Education, Culture, Sports, Science and Technology (MEXT) of Japan for supporting him with *Drosophila* resources, and Drs. H. Yonekawa and H. Suzuki for their kind help and encouragement in the early stage of this study. Financial support was also provided by NSF grant IOB-0518654 to Artyom Kopp.

### Note

Supplementary materials can be found at: [www.landesbioscience.com/supplement/MatsudaFLY3-2-Sup.pdf](http://www.landesbioscience.com/supplement/MatsudaFLY3-2-Sup.pdf)

### References

- Schug MD, Smith SG, Tozier-Pearce A, McEvey SF. The genetic structure of *Drosophila ananassae* populations from Asia, Australia and Samoa. *Genetics* 2007; 175:1429-40.
- Matsuda M, Tobari YN. Genetic analyses of several *Drosophila ananassae*-complex species show a low-frequency major gene for parthenogenesis that maps to chromosome 2. *Genet Res* 2004; 83:83-9.
- Yamada H, Matsuda M, Oguma Y. Genetics of sexual isolation based on courtship song between two sympatric species: *Drosophila ananassae* and *D. pallidosa*. *Genetica* 2002; 116:225-37.
- Yamada H, Sakai T, Tomaru M, Doi M, Matsuda M, Oguma Y. Search for species-specific mating signal in courtship songs of sympatric sibling species, *Drosophila ananassae* and *D. pallidosa*. *Genes Genet Syst* 2002; 77:97-106.
- Doi M, Matsuda M, Tomaru M, Matsubayashi H, Oguma Y. A locus for female discrimination behavior causing sexual isolation in *Drosophila*. *Proc Natl Acad Sci USA* 2001; 98:6714-9.
- Baines JE, Das A, Mousset S, Stephan W. The role of natural selection in genetic differentiation of worldwide populations of *Drosophila ananassae*. *Genetics* 2004; 168:1987-98.
- Das A, Mohanty S, Stephan W. Inferring the population structure and demography of *Drosophila ananassae* from multilocus data. *Genetics* 2004; 168:1975-85.
- Vogl C, Das A, Beaumont M, Mohanty S, Stephan W. Population subdivision and molecular sequence variation: theory and analysis of *Drosophila ananassae* data. *Genetics* 2003; 165:1385-95.
- Chen Y, Marsh BJ, Stephan W. Joint effects of natural selection and recombination on gene flow between *Drosophila ananassae* populations. *Genetics* 2000; 155:1185-94.
- Clark AG, Eisen MB, Smith DR, Bergman CM, Oliver B, et al. Evolution of genes and genomes on the *Drosophila* phylogeny. *Nature* 2007; 450:203-18.
- Zhang Y, Sturgill D, Parisi M, Kumar S, Oliver B. Constraint and turnover in sex-biased gene expression in the genus *Drosophila*. *Nature* 2007; 450:233-7.
- Sawamura K, Tomimura Y, Sato H, Yamada H, Matsuda M, Oguma Y. Establishing interspecific mosaic genome lines between *Drosophila ananassae* and *Drosophila pallidosa* by means of parthenogenesis. *Genet Res* 2006; 88:1-11.
- Kliman RM, Andolfatto P, Coyne JA, Depaulis F, Kreitman M, Berry AJ, et al. The population genetics of the origin and divergence of the *Drosophila simulans* complex species. *Genetics* 2000; 156:1913-31.
- Lachaise D, Silvain JF. How two Afrotropical endemics made two cosmopolitan human commensals: the *Drosophila melanogaster*-*D. simulans* palaeogeographic riddle. *Genetica* 2004; 120:17-39.
- Lachaise D, Cariou ML, David JR, Lemeunier F, Tsacas L, Ashburner M. Historical biogeography of the *Drosophila melanogaster* species subgroup. *Evol Biol* 1988; 22:159-225.
- Lemeunier F, Aulard S, Arienti M, Jallon JM, Cariou ML, Tsacas L. The ercepeae complex: New cases of insular speciation within the *Drosophila ananassae* species subgroup (melanogaster group) and descriptions of two new species (Diptera: Drosophilidae). *Ann Entomol Soc Am* 1997; 90:28-42.
- McEvey SF, David JR, Tsacas L. The *Drosophila ananassae* complex with description of a new species from French Polynesia (Diptera: Drosophilidae). *Anns Soc Ent Fr (NS)* 1987; 23:377-85.
- Bock IR. Current status of the *Drosophila melanogaster* species-group. (Diptera). *Syst Ent* 1980; 5:341-56.
- Bock IR, Wheeler MR. The *Drosophila melanogaster* species group. *Univ Texas Pubs* 1972; 7:1-102.
- Bock IR. Taxonomy of the *Drosophila bipectinata* species complex. *Univ Texas Pubs* 1971; 6:273-80.
- Da Lage J-L, Kergoat GJ, Maczkowiak F, Silvain J-F, Cariou M-L, Lachaise D. A phylogeny of Drosophilidae using the *Amyrel* gene: questioning the *Drosophila melanogaster* species group boundaries. *J Zool Syst Evol Res* 2007; 45:47-63.
- Pollard DA, Iyer VN, Moses AM, Eisen MB. Widespread discordance of gene trees with species tree in *Drosophila*: evidence for incomplete lineage sorting. *PLoS Genet* 2006; 2:173.
- Wong A, Jensen JD, Pool JE, Aquadro CF. Phylogenetic incongruence in the *Drosophila melanogaster* species group. *Mol Phylogenet Evol* 2007; 43:1138-50.
- Kopp A, True JR. Phylogeny of the Oriental *Drosophila melanogaster* Species Group: A Multilocus Reconstruction. *Syst Biol* 2002; 51:786-805.
- Kopp A, Barmina O. Evolutionary history of the *Drosophila bipectinata* species complex. *Genet Res* 2005; 85:23-46.
- Goldman N, Anderson JP, Rodrigo AG. Likelihood-based tests of topologies in phylogenetics. *Systematic Biology* 2000; 49:652-70.
- Shimodaira H, Hasegawa M. Multiple comparisons of log-likelihoods with applications to phylogenetic inference. *Mol Biol Evol* 1999; 16:1114-6.
- Barmina O, Kopp A. Sex-specific expression of a HOX gene associated with rapid morphological evolution. *Dev Biol* 2007; 311:277-86.
- Kopp A, True JR. Evolution of male sexual characters in the oriental *Drosophila melanogaster* species group. *Evol Devel* 2002; 4:278-91.
- Kaufmann BP, Demerec M. Frequency of Induced Breaks in Chromosomes of *Drosophila melanogaster*. *Proc Natl Acad Sci USA* 1937; 23:484-8.
- Kikkawa H. Studies on the genetics and cytology of *Drosophila ananassae*. *Genetica* 1938; 20:458-516.
- Tomimura Y, Matsuda M, Tobari YN. Chromosomal phylogeny and geographical divergence in the *Drosophila bipectinata* complex. *Genome* 2005; 48:487-502.
- Tobari YN, Goni B, Tomimura Y, Matsuda M. Chromosomes. *Tobari* 1993; 23-48.
- Tomimura Y, Matsuda M, Tobari YN, Cariou ML, Da Lage JL, Stephan W, Langley CH. Population genetics. *Tobari* 1993; 139-98.
- Das A. Population genomic and bioinformatic studies reveal evolutionary history of *Drosophila ananassae*. *Curr Sci India* 2005; 89:1316-21.
- Futch DG. A study of speciation in South Pacific populations of *Drosophila ananassae*. *Univ Tex Publ* 1966; 3:79-120.
- Schawaroch V. Phylogeny of a paradigm lineage: the *Drosophila melanogaster* species group. *Biological Journal of the Linnean Society* 2002; 76:21-37.
- Schaeffer SW, Bhutkar A, McAllister BF, Matsuda M, Matzkin LM, O'Grady PM, et al. Polyene chromosomal maps of 11 *Drosophila* species: the order of genomic scaffolds inferred from genetic and physical maps. *Genetics* 2008; 179:1601-55.
- Matsuda M, Imai H, Tobari YN. Cytogenetic analysis of recombination in males of *Drosophila ananassae*. *Chromosoma* 1983; 88:286-92.
- Roy V, Monti-Dedieu L, Chaminade N, Siljak-Yakovlev S, Aulard S, Lemeunier F, Montchamp-Moreau C. Evolution of the chromosomal location of rDNA genes in two *Drosophila* species subgroups: *ananassae* and *melanogaster*. *Heredity* 2005; 94:388-95.
- Wiens JJ. Widespread loss of sexually selected traits: how the peacock lost its spots. *Trends Ecol Evol* 2001; 16:517-23.
- Wong BB, Rosenthal GG. Female disdain for swords in a swordtail fish. *Am Nat* 2006; 167:136-40.
- Wittkopp PJ, Carroll SB, Kopp A. Evolution in black and white: genetic control of pigment patterns in *Drosophila*. *Trends Genet* 2003; 19:495-504.
- Schug MD, Baines JE, Killon-Atwood A, Mohanty S, Das A, Grath S, et al. Evolution of mating isolation between populations of *Drosophila ananassae*. *Mol Ecol* 2008; 17:2706-21.
- Tobari YN. *Drosophila ananassae*: Genetical and Biological Aspects. Tokyo: Japan Scientific Societies Press, and Karger 1993.
- Kopp A, Frank A, Barmina O. Interspecific divergence, intrachromosomal conversion and phylogenetic utility of Y-chromosomal genes in *Drosophila*. *Mol Phylogenet Evol* 2006; 38:731-41.
- Bachtrog D, Thornton K, Clark A, Andolfatto P. Extensive introgression of mitochondrial DNA relative to nuclear genes in the *Drosophila yakuba* species group. *Evolution Int J Org Evolution* 2006; 60:292-302.
- Jobling MA, Tyler-Smith C. The human Y chromosome: an evolutionary marker comes of age. *Nat Rev Genet* 2003; 4:598-612.



49. Ruiz Linares A, Nayar K, Goldstein DB, Hebert JM, Seielstad MT, Underhill PA, et al. Geographic clustering of human Y-chromosome haplotypes. *Ann Hum Genet* 1996; 60:401-8.
50. Underhill PA, Passarino G, Lin AA, Shen P, Mirazon Lahr M, Foley RA, et al. The phylogeography of Y chromosome binary haplotypes and the origins of modern human populations. *Ann Hum Genet* 2001; 65:43-62.
51. Boissinot S, Boursot P. Discordant phylogeographic patterns between the Y chromosome and mitochondrial DNA in the house mouse: selection on the Y chromosome? *Genetics* 1997; 146:1019-34.
52. Vanlerberghe F, Dod B, Boursot P, Bellis M, Bonhomme F. Absence of Y-chromosome introgression across the hybrid zone between *Mus musculus domesticus* and *Mus musculus musculus*. *Genet Res* 1986; 48:191-7.
53. Verkaar EL, Nijman IJ, Beeke M, Hanekamp E, Lenstra JA. Maternal and paternal lineages in cross-breeding bovine species. Has wisent a hybrid origin? *Mol Biol Evol* 2004; 21:1165-70.
54. Kopp A, Frank A, Fu J. Historical biogeography of *Drosophila simulans* based on Y-chromosomal sequences. *Mol Phylogenet Evol* 2006; 38:355-62.
55. Thompson JD, Higgins DG, Gibson TJ. CLUSTAL W: improving the sensitivity of progressive multiple sequence alignment through sequence weighting, position-specific gap penalties and weight matrix choice. *Nucleic Acids Res* 1994; 22:4673-80.
56. Maddison DR, Maddison WP. *MacClade 4: Analysis of phylogeny and character evolution*. Version 4.03. Sunderland, MA: Sinauer Associates 2004.
57. Swofford DL. *PAUP\*: Phylogenetic analysis using parsimony*, version 4.0. Sanderland, MA: Sinauer Associates 2000.
58. Posada D, Crandall KA. MODELTEST: testing the model of DNA substitution. *Bioinformatics* 1998; 14:817-8.
59. Ronquist F, Huelsenbeck JP. MrBayes 3: Bayesian phylogenetic inference under mixed models. *Bioinformatics* 2003; 19:1572-4.
60. Pagel M, Meade A, Barker D. Bayesian estimation of ancestral character states on phylogenies. *Syst Biol* 2004; 53:673-84.
61. Pagel M, Meade A. Bayesian Analysis of Correlated Evolution of Discrete Characters by Reversible-Jump Markov Chain Monte Carlo. *Am Nat* 2006; 167.